

Weight and Dimensions



D, V- GL						
Type	D	A mm	B mm	C mm	E mm	Weight kg*
-GL15	1/2"	75	150	30	80	3,0
-GL20	3/4	75	150	30	80	3,0
-GL25	1"	75	150	30	80	3,0
-GL40	1 1/2"	85	160	40	90	4,0

D, V- FA					
Type	d mm	D mm	A mm	Width mm	Weight kg*
-FA15	16 (1/2")	53	150	70	4,0
-FA20	22 (3/4")	63	154	70	4,5
-FA25	30 (1")	73	161	70	4,5
-FA32	39 (1 1/4")	84	167	70	5,0
-FA40	43 (1 1/2")	94	172	70	6,0
-FA50	55 (2")	109	180	70	6,0
-FA65	70 (2 1/2")	129	190	70	7,0
-FA80	82 (3")	144	197	70	8,0
-FA100	107 (4")	164	207	70	8,0
-FA125	132 (5")	194	222	70	10,0
-FA150	159 (6")	219	235	70	11,0
-FA200	207 (8")	274	263	70	15,0
-FA250	260 (10")	330	290	70	19,0
-FA300	310 (12")	385	320	70	21,0
-FA350	340 (14")	445	345	70	35,0
-FA400	390 (16")	498	375	70	40,5

D, V- GSS					
Type	D	A mm	B mm	C mm	Weight kg*
-GSS15	1/2"	100	130	35	3,0
-GSS20	3/4"	100	130	35	3,0
-GSS25	1"	100	130	35	3,0

D, V- FSS					
Type	d mm	D mm	A mm	Width mm	Weight kg*
-FSS15	16 (1/2")	53	169	15	3,0
-FSS20	22 (3/4")	63	175	15	3,0
-FSS25	30 (1")	73	183	15	3,0
-FSS32	39 (1 1/4")	84	185	15	3,0
-FSS40	43 (1 1/2")	94	190	15	3,0
-FSS50	55 (2")	109	210	15	3,0
-FSS65	70 (2 1/2")	129	220	15	3,5
-FSS80	82 (3")	144	228	15	3,5
-FSS100	107 (4")	164	238	15	4,0
-FSS125	132 (5")	194	253	15	4,5
-FSS150	159 (6")	219	266	15	5,0
-FSS200	207 (8")	274	293	15	6,5
-FSS250	260 (10")	330	320	15	8,0
-FSS300	310 (12")	385	350	15	9,5
-FSS350	340 (14")	445	375	18	14,5
-FSS400	390 (16")	498	405	18	16,5

S- GL						
Type	D	A mm	B mm	C mm	E mm	Weight kg*
-GL15	1/2"	85	150	30	80	3,5
-GL20	3/4	85	150	30	80	3,5
-GL25	1"	85	150	30	80	3,5
-GL40	1 1/2"	95	160	40	90	4,5

S- FA					
Type	d mm	D mm	A mm	Width mm	Weight kg*
-FA15	16 (1/2")	53	160	70	4,5
-FA20	22 (3/4")	63	164	70	5,0
-FA25	30 (1")	73	171	70	5,0
-FA32	39 (1 1/4")	84	177	70	5,5
-FA40	43 (1 1/2")	94	182	70	6,5
-FA50	55 (2")	109	190	70	6,5
-FA65	70 (2 1/2")	129	200	70	7,5
-FA80	82 (3")	144	207	70	8,0
-FA100	107 (4")	164	217	70	9,0
-FA125	132 (5")	194	232	70	11,0
-FA150	159 (6")	219	245	70	11,0
-FA200	207 (8")	274	273	70	15,5
-FA250	260 (10")	330	300	70	19,0
-FA300	310 (12")	385	330	70	22,0
-FA350	340 (14")	445	355	70	35,5
-FA400	390 (16")	498	385	70	41,0

S- GSS					
Type	D	A mm	B mm	C mm	Weight kg*
-GSS15	1/2"	110	130	35	3,0
-GSS20	3/4"	110	130	35	3,0
-GSS25	1"	110	130	35	3,0

S- FSS					
Type	d mm	D mm	A mm	Width mm	Weight kg*
-FSS15	16 (1/2")	53	179	15	3,0
-FSS20	22 (3/4")	63	185	15	3,0
-FSS25	30 (1")	73	193	15	3,5
-FSS32	39 (1 1/4")	84	200	15	3,5
-FSS40	43 (1 1/2")	94	205	15	3,5
-FSS50	55 (2")	109	220	15	4,0
-FSS65	70 (2 1/2")	129	230	15	4,0
-FSS80	82 (3")	144	238	15	4,0
-FSS100	107 (4")	164	248	15	4,5
-FSS125	132 (5")	194	263	15	5,0
-FSS150	159 (6")	219	276	15	5,5
-FSS200	207 (8")	274	303	15	7,0
-FSS250	260 (10")	330	330	15	9,0
-FSS300	310 (12")	385	355	15	10,0
-FSS350	340 (14")	445	385	18	15,0
-FSS400	390 (16")	498	415	18	17,0

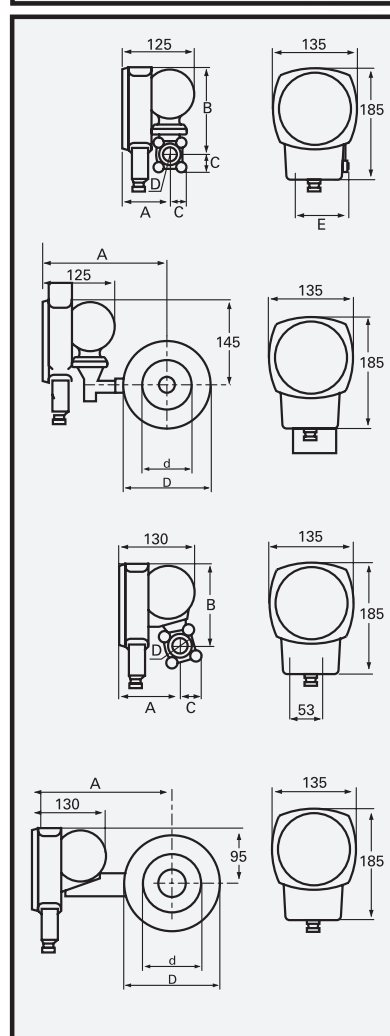
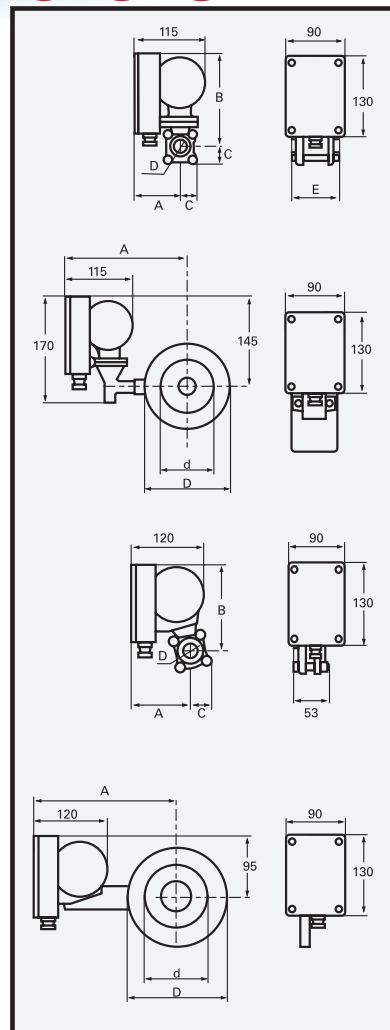

Width see table
*Approximate weight